

# 22W-PHYSICS-1C Final exam

ROHAN SRIVASTAVA

TOTAL POINTS

**70 / 70**

## QUESTION 1

10 pts

### 1.1 3 / 3

- ✓ + 3 pts Correct option selected.
- + 0 pts Incorrect option selected.

### 1.2 2 / 2

- ✓ + 2 pts Correct option selected.
- + 0 pts Incorrect option selected.

### 1.3 3 / 3

- ✓ + 3 pts Correct option selected.
- + 0 pts Incorrect option selected.

### 1.4 2 / 2

- ✓ + 2 pts Correct option selected.
- + 0 pts Incorrect option selected.

## QUESTION 2

10 pts

### 2.1 3 / 3

- ✓ - 0 pts Correct
- 1.5 pts Incorrect formula
- 0.5 pts Numerical error
- 3 pts Blank
- 0.25 pts Minus sign

### 2.2 4 / 4

- ✓ - 0 pts Correct
- 1.5 pts Incorrect formula
- 1.5 pts Unfinished
- 1 pts Numerical error
- 4 pts Blank

### 2.3 3 / 3

- ✓ - 0 pts Correct
- 1.5 pts Incorrect formula
- 0.5 pts Numerical error
- 0.5 pts Correct but find something else
- 1 pts Lack of or wrong explanation
- 3 pts Blank
- 1 pts Incomplete

## QUESTION 3

10 pts

### 3.1 3 / 3

- ✓ + 1.5 pts Correct expression for  $f$
- ✓ + 1.5 pts Correct value for  $f$

### 3.2 4 / 4

- ✓ + 1 pts Correct expression for Magnification.
- ✓ + 1 pts Set Magnification to  $m = \frac{1}{3}$ .
- ✓ + 1 pts Correct expression for  $f$ .
- ✓ + 1 pts Correct Value for  $f$
- + 0 pts Not Attempted

### 3.3 3 / 3

- ✓ + 1 pts Correct expression for magnification  $m$
- ✓ + 1 pts Correct expression for image distance.
- ✓ + 1 pts Correct value and direction for image distance.
- + 0 pts Not Attempted

## QUESTION 4

10 pts

### 4.1 3 / 3

- ✓ - 0 pts Correct
- 1.5 pts Incorrect formula

- 0.5 pts Numerical error for gamma
- 1 pts Numerical error
- 3 pts Blank

#### 4.2 3 / 3

- ✓ - 0 pts Correct
- 1.5 pts Incorrect formula
- 1 pts Numerical error
- 3 pts Blank

#### 4.3 4 / 4

- ✓ - 0 pts Correct
- 1 pts Incorrect time for strike at  $t'=0$ ,  $x'=0$
- 1 pts Incorrect coordinate for strike at  $t'=0$ ,  $x'=0$
- 1 pts Incorrect time for strike at  $t'=0$ ,  $x'=2$
- 1 pts Incorrect coordinate for strike at  $t'=0$ ,  $x'=2$
- 0.5 pts Numerical error
- 1 pts Numerical error
- 4 pts Blank

#### QUESTION 5

##### 5 10 / 10

- ✓ + 1.5 pts Correct expression for magnetic field of a solenoid  $B = \mu_0 n i$ , where  $n = \frac{N}{l}$
- ✓ + 1 pts Correct value for  $n = 5000 \frac{\text{turns}}{\text{m}}$  in SI units.
- ✓ + 1.5 pts Correct expression for circular motion for the electron  $F_c = \frac{mv^2}{R}$  and  $F_B = qvB$ .
- ✓ + 2 pts Set  $F_b = F_c$  to calculate  $B$
- ✓ + 1 pts Correct expression for  $B = \frac{mv}{qR}$  and
- ✓ + 2 pts Use  $B$  to calculate  $i$  by plugging it into  $i = \frac{B}{\mu_0 n}$
- ✓ + 1 pts Correct numerical value for  $i$
- + 0 pts Not Attempted

#### QUESTION 6

10 pts

##### 6.1 2 / 2

- ✓ - 0 pts Correct

- 1 pts Incorrect formula
- 0.5 pts Numerical error

##### 6.2 2 / 2

- ✓ - 0 pts Correct
- 1 pts Incorrect formula
- 0.5 pts Numerical error
- 0.25 pts Successive numerical error
- 2 pts Blank

##### 6.3 3 / 3

- ✓ - 0 pts Correct
- 1 pts Incorrect formula for E
- 1 pts Incorrect or no formula for B
- 0.5 pts Numerical error
- 0.25 pts Numerical error for B
- 3 pts Blank

##### 6.4 3 / 3

- ✓ - 0 pts Correct
- 1.5 pts Incorrect formula
- 0.25 pts Successive numerical error
- 0.5 pts Numerical error
- 3 pts Blank

#### QUESTION 7

10 pts

##### 7.1 5 / 5

- ✓ - 0 pts Correct
- 2 pts Incorrect Kirchhoff's laws
- 1.5 pts Solving differential equation
- 1 pts Error in expression
- 0.5 pts Incorrect  $I_0$
- 1 pts Incorrect  $I_0$
- 3 pts Incorrect expression with no explanation
- 5 pts Blank
- 2 pts Correct general form but with no specification
- 3 pts Correct but incomplete

##### 7.2 5 / 5

✓ - **0 pts** Correct

- **2 pts** Error in the expression of  $P_L$
- **1 pts** Error in the expression of  $P_L$
- **2 pts** Error in the way to find  $t$  for maximal  $P_L$
- **1 pts** Error in the way to find  $t$  for maximal  $P_L$
- **1.5 pts** No answer to  $t$  for maximal  $P_L$
- **1 pts** Incomplete in finding  $t$  for maximal  $P_L$
- **1 pts** Numerical error
- **0.5 pts** Numerical error
- **3 pts** Incomplete
- **5 pts** Blank

Problem 1 (10 pts)

Please **be very careful** in writing down your answers for these two questions. They are graded by the final answers **ONLY**, no partial credits for any intermediate steps.

$$m = -\frac{y'}{y} = -\frac{s'}{s} = -\frac{-10}{10} = -1$$

(a) (3 pts) An object 0.65 cm tall is placed 10 cm to the left of a thin converging lens, which has a focal length of 5.0 cm. Determine the nature of the image. Your choice: C

$$\frac{1}{s} + \frac{1}{s'} = \frac{1}{f}$$

$$\frac{1}{10} + \frac{1}{s'} = \frac{1}{5}$$

$$s' = 10 \text{ cm } \rightarrow 0 \text{ r.l.}$$

- a. Enlarged inverted real      b. Shranked erect virtual      c. equal inverted real  
 d. equal inverted virtual      e. Enlarged erect real      f. Shranked inverted real

(b) (2 pts) In our universe, the speed of light is a constant  $c = 3.0 \times 10^8$  m/s. Now let us imagine an alternative universe where the speed of light is 1,000,000 times less than it is in our universe to see what happen. An airplane has a length of 60 m when measured at rest. When the airplane is moving at 180 m/s in the alternate universe, how long would the plane appear to be to a stationary observer? C

$$l_0 = 60 \text{ m}$$

$$c' = 300 \text{ m/s}$$

$$\gamma = \frac{1}{\sqrt{1 - (v/c')^2}} = 1.25$$

$$l = \frac{l_0}{\gamma} = \frac{60}{1.25} = 48 \text{ m}$$

- a. 24 m      b. 36 m      c. 48 m      d. 60 m      e. 75 m

(c) (3 pts) The figure shows a square loop of wire that lies in the  $xy$ -plane. The loop carries a constant current  $I$  in the clockwise direction. The magnetic field has no  $x$  component but has both  $y$  and  $z$  components:  $\vec{B} = \frac{B_0}{L}(z \hat{j} + y \hat{k})$ , where  $B_0$  is a positive constant. Find the direction of the force on the side, that runs from  $(0,0)$  to  $(0,L)$ . Your choice: a

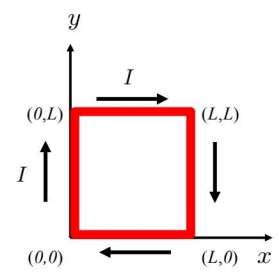

- a.  $+x$       b.  $-x$       c.  $+y$       d.  $-y$       e.  $+z$       f.  $-z$       g. 0

(d) (2 pts) The positive directions of the vector area  $\vec{A}$  for the conducting loop and the magnetic field  $\vec{B}$  are shown in the figure on the right. The magnetic field is increasing, what is the direction of the induced emf. Your choice: a

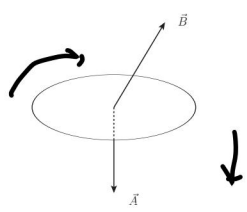

- a. clockwise      b. counterclockwise      c. undetermined, no enough information

1.1 3 / 3

✓ + 3 pts Correct option selected.

+ 0 pts Incorrect option selected.

Problem 1 (10 pts)

Please **be very careful** in writing down your answers for these two questions. They are graded by the final answers **ONLY**, no partial credits for any intermediate steps.

$$m = \frac{y'}{y} = \frac{-s'}{s} = \frac{-10}{10} = -1$$

(a) (3 pts) An object 0.65 cm tall is placed 10 cm to the left of a thin converging lens, which has a focal length of 5.0 cm. Determine the nature of the image. Your choice: C

$$\frac{1}{s} + \frac{1}{s'} = \frac{1}{f}$$

$$\frac{1}{10} + \frac{1}{s'} = \frac{1}{5}$$

$$s' = 10 \text{ cm } \rightarrow 0 \text{ r.l.}$$

- a. Enlarged inverted real      b. Shranked erect virtual      c. equal inverted real  
 d. equal inverted virtual      e. Enlarged erect real      f. Shranked inverted real

(b) (2 pts) In our universe, the speed of light is a constant  $c = 3.0 \times 10^8$  m/s. Now let us imagine an alternative universe where the speed of light is 1,000,000 times less than it is in our universe to see what happen. An airplane has a length of 60 m when measured at rest. When the airplane is moving at 180 m/s in the alternate universe, how long would the plane appear to be to a stationary observer? C

$$l_0 = 60 \text{ m}$$

$$c' = 300 \text{ m/s}$$

$$\gamma = \frac{1}{\sqrt{1 - (v/c')^2}} = 1.25$$

$$l = \frac{l_0}{\gamma} = \frac{60}{1.25} = 48 \text{ m}$$

- a. 24 m      b. 36 m      c. 48 m      d. 60 m      e. 75 m

(c) (3 pts) The figure shows a square loop of wire that lies in the  $xy$ -plane. The loop carries a constant current  $I$  in the clockwise direction. The magnetic field has no  $x$  component but has both  $y$  and  $z$  components:  $\vec{B} = \frac{B_0}{L}(z \hat{j} + y \hat{k})$ , where  $B_0$  is a positive constant. Find the direction of the force on the side, that runs from  $(0,0)$  to  $(0,L)$ . Your choice: a

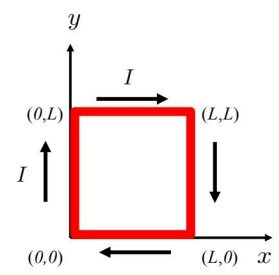

- a.  $+x$       b.  $-x$       c.  $+y$       d.  $-y$       e.  $+z$       f.  $-z$       g. 0

(d) (2 pts) The positive directions of the vector area  $\vec{A}$  for the conducting loop and the magnetic field  $\vec{B}$  are shown in the figure on the right. The magnetic field is increasing, what is the direction of the induced emf. Your choice: a

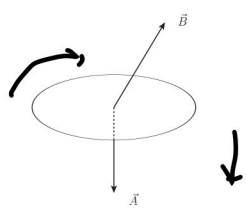

- a. clockwise      b. counterclockwise      c. undetermined, no enough information

1.2 2 / 2

✓ + 2 pts Correct option selected.

+ 0 pts Incorrect option selected.

Problem 1 (10 pts)

Please **be very careful** in writing down your answers for these two questions. They are graded by the final answers **ONLY**, no partial credits for any intermediate steps.

$$m = \frac{y'}{y} = \frac{-s'}{s} = \frac{-10}{10} = -1$$

(a) (3 pts) An object 0.65 cm tall is placed 10 cm to the left of a thin converging lens, which has a focal length of 5.0 cm. Determine the nature of the image. Your choice: C

$$\frac{1}{s} + \frac{1}{s'} = \frac{1}{f}$$

$$\frac{1}{10} + \frac{1}{s'} = \frac{1}{5}$$

$$s' = 10 \text{ cm } \rightarrow 0 \text{ r.l.}$$

- a. Enlarged inverted real      b. Shranked erect virtual      c. equal inverted real  
 d. equal inverted virtual      e. Enlarged erect real      f. Shranked inverted real

(b) (2 pts) In our universe, the speed of light is a constant  $c = 3.0 \times 10^8$  m/s. Now let us imagine an alternative universe where the speed of light is 1,000,000 times less than it is in our universe to see what happen. An airplane has a length of 60 m when measured at rest. When the airplane is moving at 180 m/s in the alternate universe, how long would the plane appear to be to a stationary observer? C

$$l_0 = 60 \text{ m}$$

$$c' = 300 \text{ m/s}$$

$$\gamma = \frac{1}{\sqrt{1 - (v/c')^2}} = 1.25$$

$$l = \frac{l_0}{\gamma} = \frac{60}{1.25} = 48 \text{ m}$$

- a. 24 m      b. 36 m      c. 48 m      d. 60 m      e. 75 m

(c) (3 pts) The figure shows a square loop of wire that lies in the  $xy$ -plane. The loop carries a constant current  $I$  in the clockwise direction. The magnetic field has no  $x$  component but has both  $y$  and  $z$  components:  $\vec{B} = \frac{B_0}{L}(z \hat{j} + y \hat{k})$ , where  $B_0$  is a positive constant. Find the direction of the force on the side, that runs from  $(0,0)$  to  $(0,L)$ . Your choice: a

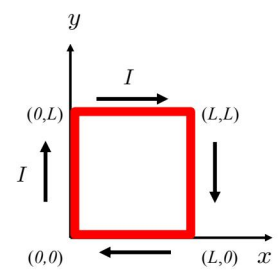

- a.  $+x$       b.  $-x$       c.  $+y$       d.  $-y$       e.  $+z$       f.  $-z$       g. 0

(d) (2 pts) The positive directions of the vector area  $\vec{A}$  for the conducting loop and the magnetic field  $\vec{B}$  are shown in the figure on the right. The magnetic field is increasing, what is the direction of the induced emf. Your choice: a

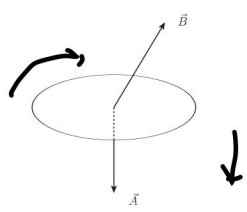

- a. clockwise      b. counterclockwise      c. undetermined, no enough information



1.3 3 / 3

✓ + 3 pts Correct option selected.

+ 0 pts Incorrect option selected.

Problem 1 (10 pts)

Please **be very careful** in writing down your answers for these two questions. They are graded by the final answers **ONLY**, no partial credits for any intermediate steps.

$$m = \frac{y'}{y} = \frac{-s'}{s} = \frac{-10}{10} = -1$$

(a) (3 pts) An object 0.65 cm tall is placed 10 cm to the left of a thin converging lens, which has a focal length of 5.0 cm. Determine the nature of the image. Your choice: C

$$\frac{1}{s} + \frac{1}{s'} = \frac{1}{f}$$

$$\frac{1}{10} + \frac{1}{s'} = \frac{1}{5}$$

$$s' = 10 \text{ cm } \rightarrow 0 \text{ r.l.}$$

- a. Enlarged inverted real      b. Shranked erect virtual      c. equal inverted real  
 d. equal inverted virtual      e. Enlarged erect real      f. Shranked inverted real

(b) (2 pts) In our universe, the speed of light is a constant  $c = 3.0 \times 10^8$  m/s. Now let us imagine an alternative universe where the speed of light is 1,000,000 times less than it is in our universe to see what happen. An airplane has a length of 60 m when measured at rest. When the airplane is moving at 180 m/s in the alternate universe, how long would the plane appear to be to a stationary observer? C

$$l_0 = 60 \text{ m}$$

$$c' = 300 \text{ m/s}$$

$$\gamma = \frac{1}{\sqrt{1 - (v/c')^2}} = 1.25$$

$$l = \frac{l_0}{\gamma} = \frac{60}{1.25} = 48 \text{ m}$$

- a. 24 m      b. 36 m      c. 48 m      d. 60 m      e. 75 m

(c) (3 pts) The figure shows a square loop of wire that lies in the  $xy$ -plane. The loop carries a constant current  $I$  in the clockwise direction. The magnetic field has no  $x$  component but has both  $y$  and  $z$  components:  $\vec{B} = \frac{B_0}{L}(z \hat{j} + y \hat{k})$ , where  $B_0$  is a positive constant. Find the direction of the force on the side, that runs from  $(0,0)$  to  $(0,L)$ . Your choice: a

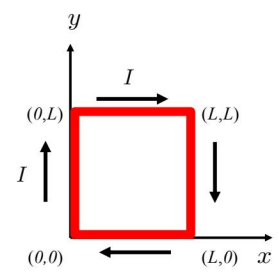

- a.  $+x$       b.  $-x$       c.  $+y$       d.  $-y$       e.  $+z$       f.  $-z$       g. 0

(d) (2 pts) The positive directions of the vector area  $\vec{A}$  for the conducting loop and the magnetic field  $\vec{B}$  are shown in the figure on the right. The magnetic field is increasing, what is the direction of the induced emf. Your choice: a

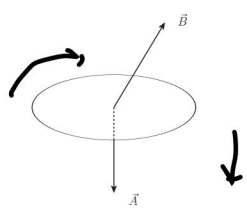

- a. clockwise      b. counterclockwise      c. undetermined, no enough information

1.4 2 / 2

✓ + 2 pts Correct option selected.

+ 0 pts Incorrect option selected.

Problem 2 (10 pts)

Please make sure to write down *intermediate steps* of your calculations, for partial credits.

As shown in the figure, Tom performed a single-slit diffraction experiment using a laser beam. The intensity at the center of the diffraction pattern is  $I_0$ . Please answer the following questions

- (a) (3 pts) What is the intensity at a point in the pattern where there is a 66-radian phase difference between wavelets from the two edges of the slit?
- (b) (4 pts) If this point is  $7.0^\circ$  away from the central maximum, how many wavelengths wide is the slit?
- (c) (3 pts) Tom kept adjusting the wavelength of the laser beam. When the wavelength of the laser beam is 580 nm, he found that the first diffraction minima are at  $\pm 90^\circ$ , so the central maximum completely fills the screen. What is the width  $a$  of the slit?

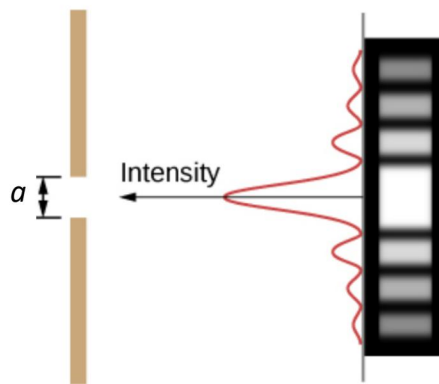

$$a) I = I_0 \left( \frac{\sin(\beta/2)}{\beta/2} \right)^2$$

$$I = I_0 \left( \frac{\sin(33)}{33} \right)^2 = \boxed{9.18 \times 10^{-4} I_0}$$

$$\beta = \frac{2\pi}{\lambda} a \sin \theta = 66 \text{ rad}$$

$$\beta/2 = 33 \text{ rad}$$

$$b) \beta = \frac{2\pi}{\lambda} a \sin \theta$$

$$7^\circ \cdot \frac{\pi}{180} = 0.122 \text{ rads}$$

$$a = \frac{\beta \cdot \lambda}{2\pi \cdot \sin(\theta)} = \frac{66 \lambda}{0.77} = 86.2 \lambda$$

$$\boxed{86.2 \text{ wavelengths}}$$

2.1 3 / 3

✓ - 0 pts Correct

- 1.5 pts Incorrect formula

- 0.5 pts Numerical error

- 3 pts Blank

- 0.25 pts Minus sign

Problem 2 (10 pts)

Please make sure to write down *intermediate steps* of your calculations, for partial credits.

As shown in the figure, Tom performed a single-slit diffraction experiment using a laser beam. The intensity at the center of the diffraction pattern is  $I_0$ . Please answer the following questions

- (a) (3 pts) What is the intensity at a point in the pattern where there is a 66-radian phase difference between wavelets from the two edges of the slit?
- (b) (4 pts) If this point is  $7.0^\circ$  away from the central maximum, how many wavelengths wide is the slit?
- (c) (3 pts) Tom kept adjusting the wavelength of the laser beam. When the wavelength of the laser beam is 580 nm, he found that the first diffraction minima are at  $\pm 90^\circ$ , so the central maximum completely fills the screen. What is the width  $a$  of the slit?

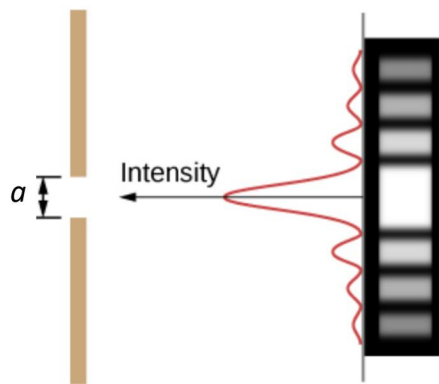

$$a) I = I_0 \left( \frac{\sin(\beta/2)}{\beta/2} \right)^2$$

$$I = I_0 \left( \frac{\sin(33)}{33} \right)^2 = \boxed{9.18 \times 10^{-4} I_0}$$

$$\beta = \frac{2\pi}{\lambda} a \sin \theta = 66 \text{ rad}$$

$$\beta/2 = 33 \text{ rad}$$

$$b) \beta = \frac{2\pi}{\lambda} a \sin \theta$$

$$7^\circ \cdot \frac{\pi}{180} = 0.122 \text{ rad}$$

$$a = \frac{\beta \cdot \lambda}{2\pi \cdot \sin(\theta)} = \frac{66 \lambda}{0.77} = 86.2 \lambda$$

$$\boxed{86.2 \text{ wavelengths}}$$

2.2 4 / 4

✓ - **0 pts** Correct

- **1.5 pts** Incorrect formula

- **1.5 pts** Unfinished

- **1 pts** Numerical error

- **4 pts** Blank

Problem 2 (10 pts)

Please make sure to write down *intermediate steps* of your calculations, for partial credits.

As shown in the figure, Tom performed a single-slit diffraction experiment using a laser beam. The intensity at the center of the diffraction pattern is  $I_0$ . Please answer the following questions

- (a) (3 pts) What is the intensity at a point in the pattern where there is a 66-radian phase difference between wavelets from the two edges of the slit?
- (b) (4 pts) If this point is  $7.0^\circ$  away from the central maximum, how many wavelengths wide is the slit?
- (c) (3 pts) Tom kept adjusting the wavelength of the laser beam. When the wavelength of the laser beam is 580 nm, he found that the first diffraction minima are at  $\pm 90^\circ$ , so the central maximum completely fills the screen. What is the width  $a$  of the slit?

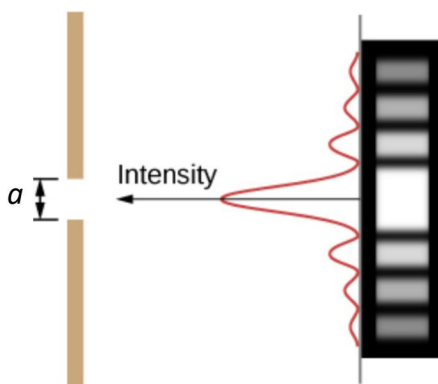

$$c) \sin \theta = \frac{m\lambda}{a}$$

$$\sin(90) = \frac{1(580 \times 10^{-9})}{a}$$

$$a = \frac{580 \times 10^{-9}}{\sin(90)} = \boxed{580 \text{ nm}}$$



2.3 3 / 3

✓ - **0 pts** Correct

- **1.5 pts** Incorrect formula

- **0.5 pts** Numerical error

- **0.5 pts** Correct but find something else

- **1 pts** Lack of or wrong explanation

- **3 pts** Blank

- **1 pts** Incomplete

Problem 3 (10 pts)

Please make sure to write down *intermediate steps* of your calculations, for partial credits.

Suppose the absolute values of the radii of curvature of the lens surface in the following figure are both equal to 20.0 cm, and the index of refraction of the glass is  $n = 1.50$ .

- (a) (3 pts) What is the focal length  $f$  of the lens? Is  $f$  positive or negative?
- (b) (4 pts) You want to use this lens to form an erect, virtual image that is  $1/3$  the height of the object. Where should the object be placed?
- (c) (3 pts) Where will the image be? Compute the image distance and point out whether the image is on the left side or the right side of the lens?

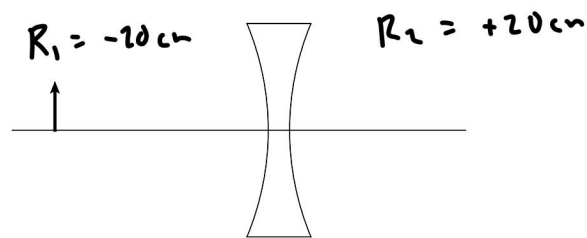

$$\begin{aligned} \text{a)} \quad \frac{1}{f} &= (1.5 - 1) \left( \frac{1}{-20} - \frac{1}{20} \right) \\ &= 0.5 \left( -\frac{1}{10} \right) \end{aligned}$$

$$f = -20 \text{ cm}, \text{ } f \text{ is negative}$$

$$\text{b)} \quad \frac{1}{s} + \frac{1}{s'} = \frac{1}{f} \quad m = \frac{y'}{y} = -\frac{s'}{s} = \frac{1}{3} \quad s' = -\frac{1}{3}s$$

$$\frac{1}{s} + \frac{1}{-\frac{1}{3}s} = \frac{1}{f} \quad \frac{1}{s} - \frac{3}{s} = \frac{1}{f}$$

$$-\frac{2}{s} = \frac{1}{-20}$$

$$s = 40 \text{ cm}$$

object should be placed 40 cm left of lens

3.1 3 / 3

✓ + 1.5 pts Correct expression for \$\$\$

✓ + 1.5 pts Correct value for \$\$\$

Problem 3 (10 pts)

Please make sure to write down *intermediate steps* of your calculations, for partial credits.

Suppose the absolute values of the radii of curvature of the lens surface in the following figure are both equal to 20.0 cm, and the index of refraction of the glass is  $n = 1.50$ .

- (a) (3 pts) What is the focal length  $f$  of the lens? Is  $f$  positive or negative?
- (b) (4 pts) You want to use this lens to form an erect, virtual image that is  $1/3$  the height of the object. Where should the object be placed?
- (c) (3 pts) Where will the image be? Compute the image distance and point out whether the image is on the left side or the right side of the lens?

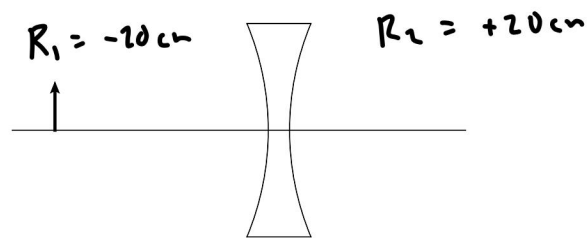

$$\begin{aligned} \text{a)} \quad \frac{1}{f} &= (1.5 - 1) \left( \frac{1}{-20} - \frac{1}{20} \right) \\ &= 0.5 \left( -\frac{1}{10} \right) \end{aligned}$$

$$f = -20 \text{ cm}, \text{ } f \text{ is negative}$$

$$\text{b)} \quad \frac{1}{s} + \frac{1}{s'} = \frac{1}{f} \quad m = \frac{y'}{y} = -\frac{s'}{s} = \frac{1}{3} \quad s' = -\frac{1}{3}s$$

$$\frac{1}{s} + \frac{1}{-\frac{1}{3}s} = \frac{1}{f} \quad \frac{1}{s} - \frac{3}{s} = \frac{1}{f}$$

$$-\frac{2}{s} = \frac{1}{-20}$$

$$s = 40 \text{ cm}$$

object should be placed 40 cm left of lens

3.2 4 / 4

- ✓ + 1 pts Correct expression for Magnification.
- ✓ + 1 pts Set Magnification to  $m = \frac{1}{3}$ .
- ✓ + 1 pts Correct expression for  $f$ .
- ✓ + 1 pts Correct Value for  $f$ .
- + 0 pts Not Attempted

Problem 3 (10 pts)

Please make sure to write down *intermediate steps* of your calculations, for partial credits.

Suppose the absolute values of the radii of curvature of the lens surface in the following figure are both equal to 20.0 cm, and the index of refraction of the glass is  $n = 1.50$ .

- (a) (3 pts) What is the focal length  $f$  of the lens? Is  $f$  positive or negative?
- (b) (4 pts) You want to use this lens to form an erect, virtual image that is  $1/3$  the height of the object. Where should the object be placed?
- (c) (3 pts) Where will the image be? Compute the image distance and point out whether the image is on the left side or the right side of the lens?

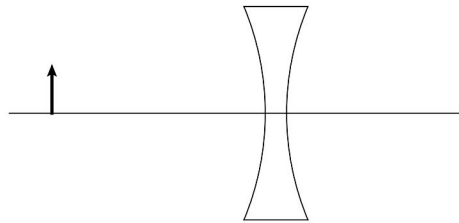

$$c) s' = -\frac{1}{3}s = -\frac{1}{3}(40) = -13.3 \text{ cm}$$

image is 13.3 cm to left of lens

3.3 3 / 3

- ✓ + 1 pts Correct expression for magnification  $m$
- ✓ + 1 pts Correct expression for image distance.
- ✓ + 1 pts Correct value and direction for image distance.
- + 0 pts Not Attempted

Problem 4 (10 pts)

Please make sure to write down *intermediate steps* of your calculations, for partial credits.

Tom and Mary are astronauts and are now both driving their own spaceship, flying in the space. Tom's spaceship moves with a speed  $0.6c$  with respect to Mary's spaceship. At the time 0, Tom and Mary's spaceships are both at origin of their corresponding frames. Mary stands at the origin: at  $t = 0$ , she turns on a laser; and after 0.400 second, she turns it off.

- (a) (3 pts) What is the time duration between on and off of the laser as seen by Tom?
- (b) (3 pts) A ruler of length 1 m is laid out on the  $x$ -axis in Mary's spaceship, what is the length of the ruler as observed by Tom?
- (c) (4 pts) In Tom's spaceship, at time 0, a lightning strikes at the origin and another lightning strikes at the position 2.00 m in the  $x$ -axis in Tom's frame. Please find the coordinates and times for the two lightning events as seen by Mary in her frame.

$$a) \Delta t_0 = 0.4 \text{ s}$$

$$\Delta t = \gamma \Delta t_0 \quad \gamma = \frac{1}{\sqrt{1 - \frac{(0.6c)^2}{c^2}}} = 1.25$$

$$\Delta t = 1.25 (0.4) = \boxed{0.5 \text{ s}}$$

$$b) l = \frac{l_0}{\gamma} = \frac{1}{1.25} = \boxed{0.8 \text{ m}}$$

$$c) \Delta t' = 0 \quad \Delta x' = 2 \text{ m} \quad \Delta t = \gamma \left[ \Delta t' + \frac{u}{c^2} \Delta x' \right]$$

$$\Delta t = \gamma \left[ \frac{u}{c^2} \Delta x' \right] = 1.25 \left( \frac{0.6c}{c^2} \cdot 2 \right) = 5 \times 10^{-9} \text{ s}$$

$$\Delta x' = \gamma [\Delta x - u \Delta t]$$

$$2 = 1.25 [\Delta x - 0.6c (5 \times 10^{-9})]$$

$$1.6 + 0.6c (5 \times 10^{-9}) = \Delta x$$

$$\Delta x = 2.5 \text{ m}$$

strike 1: $x = 0 \text{ m}$ $t = 0 \text{ s}$
strike 2: $x = 2.5 \text{ m}$ $t = 5 \times 10^{-9} \text{ s}$



4.1 3 / 3

✓ - 0 pts Correct

- 1.5 pts Incorrect formula

- 0.5 pts Numerical error for gamma

- 1 pts Numerical error

- 3 pts Blank

Problem 4 (10 pts)

Please make sure to write down *intermediate steps* of your calculations, for partial credits.

Tom and Mary are astronauts and are now both driving their own spaceship, flying in the space. Tom's spaceship moves with a speed  $0.6c$  with respect to Mary's spaceship. At the time 0, Tom and Mary's spaceships are both at origin of their corresponding frames. Mary stands at the origin: at  $t = 0$ , she turns on a laser; and after 0.400 second, she turns it off.

- (a) (3 pts) What is the time duration between on and off of the laser as seen by Tom?
- (b) (3 pts) A ruler of length 1 m is laid out on the  $x$ -axis in Mary's spaceship, what is the length of the ruler as observed by Tom?
- (c) (4 pts) In Tom's spaceship, at time 0, a lightning strikes at the origin and another lightning strikes at the position 2.00 m in the  $x$ -axis in Tom's frame. Please find the coordinates and times for the two lightning events as seen by Mary in her frame.

$$a) \Delta t_0 = 0.4 \text{ s}$$

$$\Delta t = \gamma \Delta t_0 \quad \gamma = \frac{1}{\sqrt{1 - \frac{(0.6c)^2}{c^2}}} = 1.25$$

$$\Delta t = 1.25 (0.4) = \boxed{0.5 \text{ s}}$$

$$b) l = \frac{l_0}{\gamma} = \frac{1}{1.25} = \boxed{0.8 \text{ m}}$$

$$c) \Delta t' = 0 \quad \Delta x' = 2 \text{ m} \quad \Delta t = \gamma \left[ \Delta t' + \frac{u}{c^2} \Delta x' \right]$$

$$\Delta t = \gamma \left[ \frac{u}{c^2} \Delta x' \right] = 1.25 \left( \frac{0.6c}{c^2} \cdot 2 \right) = 5 \times 10^{-9} \text{ s}$$

$$\Delta x' = \gamma [\Delta x - u \Delta t]$$

$$2 = 1.25 [\Delta x - 0.6c (5 \times 10^{-9})]$$

$$1.6 + 0.6c (5 \times 10^{-9}) = \Delta x$$

$$\Delta x = 2.5 \text{ m}$$

strike 1: $x = 0 \text{ m} \quad t = 0 \text{ s}$ strike 2: $x = 2.5 \text{ m} \quad t = 5 \times 10^{-9} \text{ s}$
---

4.2 3 / 3

✓ - 0 pts Correct

- 1.5 pts Incorrect formula

- 1 pts Numerical error

- 3 pts Blank

Problem 4 (10 pts)

Please make sure to write down *intermediate steps* of your calculations, for partial credits.

Tom and Mary are astronauts and are now both driving their own spaceship, flying in the space. Tom's spaceship moves with a speed  $0.6c$  with respect to Mary's spaceship. At the time 0, Tom and Mary's spaceships are both at origin of their corresponding frames. Mary stands at the origin: at  $t = 0$ , she turns on a laser; and after 0.400 second, she turns it off.

- (a) (3 pts) What is the time duration between on and off of the laser as seen by Tom?
- (b) (3 pts) A ruler of length 1 m is laid out on the  $x$ -axis in Mary's spaceship, what is the length of the ruler as observed by Tom?
- (c) (4 pts) In Tom's spaceship, at time 0, a lightning strikes at the origin and another lightning strikes at the position 2.00 m in the  $x$ -axis in Tom's frame. Please find the coordinates and times for the two lightning events as seen by Mary in her frame.

$$a) \Delta t_0 = 0.4 \text{ s}$$

$$\Delta t = \gamma \Delta t_0 \quad \gamma = \frac{1}{\sqrt{1 - \frac{(0.6c)^2}{c^2}}} = 1.25$$

$$\Delta t = 1.25 (0.4) = \boxed{0.5 \text{ s}}$$

$$b) l = \frac{l_0}{\gamma} = \frac{1}{1.25} = \boxed{0.8 \text{ m}}$$

$$c) \Delta t' = 0 \quad \Delta x' = 2 \text{ m} \quad \Delta t = \gamma \left[ \Delta t' + \frac{u}{c^2} \Delta x' \right]$$

$$\Delta t = \gamma \left[ \frac{u}{c^2} \Delta x' \right] = 1.25 \left( \frac{0.6c}{c^2} \cdot 2 \right) = 5 \times 10^{-9} \text{ s}$$

$$\Delta x' = \gamma [\Delta x - u \Delta t]$$

$$2 = 1.25 [\Delta x - 0.6c (5 \times 10^{-9})]$$

$$1.6 + 0.6c (5 \times 10^{-9}) = \Delta x$$

$$\Delta x = 2.5 \text{ m}$$

strike 1: $x = 0 \text{ m}$ $t = 0 \text{ s}$
strike 2: $x = 2.5 \text{ m}$ $t = 5 \times 10^{-9} \text{ s}$

4.3 4 / 4

✓ - 0 pts Correct

- 1 pts Incorrect time for strike at  $t'=0$ ,  $x'=0$
- 1 pts Incorrect coordinate for strike at  $t'=0$ ,  $x'=0$
- 1 pts Incorrect time for strike at  $t'=0$ ,  $x'=2$
- 1 pts Incorrect coordinate for strike at  $t'=0$ ,  $x'=2$
- 0.5 pts Numerical error
- 1 pts Numerical error
- 4 pts Blank

Problem 5 (10 pts)

Please make sure to write down *intermediate steps* of your calculations, for partial credits.

A solenoid with 50 turns per centimeter carries a current  $I$ . An electron moves within the solenoid in a circle that has a radius of 4.0 cm and is perpendicular to the axis of the solenoid. We have electron mass  $m = 9.1 \times 10^{-31}$  kg, and its charge is given by  $e = -1.60 \times 10^{-19}$  C. If the speed of the electron is  $8.0 \times 10^5$  m/s, what is the current  $I$ ?

$$v = 8 \times 10^5$$

$$F = qv \times B = qvB \text{ since perpendicular}$$

$$B = \mu_0 n I$$

$$qvB = \frac{mv^2}{R}$$

$$n = \# \text{ of turns/m}$$

$$n = \frac{50 \text{ turns}}{\text{cm}} \cdot \frac{100 \text{ cm}}{1 \text{ m}} = 5000 \text{ turns/m}$$

$$B = \frac{mv}{qR} = \mu_0 n I$$

$$I = \frac{mv}{\mu_0 n q R} = \frac{(9.1 \times 10^{-31}) (8 \times 10^5)}{(4\pi \times 10^{-7}) (5000) (-1.6 \times 10^{-19}) (0.04)} = \boxed{0.018 \text{ A}}$$

5 10 / 10

- ✓ + 1.5 pts Correct expression for magnetic field of a solenoid  $B = \mu_0 n i$ , where  $n = \frac{N}{l}$
- ✓ + 1 pts Correct value for  $n = 5000 \frac{\text{turns}}{\text{m}}$  in SI units.
- ✓ + 1.5 pts Correct expression for circular motion for the electron  $F_c = \frac{mv^2}{R}$  and  $F_B = qvB$ .
- ✓ + 2 pts Set  $F_b = F_c$  to calculate  $B$
- ✓ + 1 pts Correct expression for  $B = \frac{mv}{qR}$  and
- ✓ + 2 pts Use  $B$  to calculate  $i$  by plugging it into  $i = \frac{B}{\mu_0 n}$
- ✓ + 1 pts Correct numerical value for  $i$
- + 0 pts Not Attempted

Problem 6 (10 pts)

Please make sure to write down *intermediate steps* of your calculations, for partial credits.

A new professor in the university recently built his own laser. This laser can produce light of wavelength 500 nm and a power of 0.500 mW spread over a cylindrical beam with 1.00 mm in radius.

- (a) (2 pts) What is the intensity of this laser beam?
- (b) (2 pts) What average pressure does this laser exert on a totally reflecting surface?
- (c) (3 pts) What are the maximum values of the electric and magnetic fields?
- (d) (3 pts) What is the average energy density in the laser beam?

$$a) P_{av} = IA \quad I = \frac{P}{A} = \frac{0.5 \times 10^{-3}}{\pi (1 \times 10^{-3})^2} = \boxed{159.15 \text{ W/m}^2}$$

$$b) P_{rad} = \frac{2I}{c} = \frac{2 (159.15)}{3 \times 10^8} = \boxed{1.06 \times 10^{-6} \text{ Pa}}$$

$$c) I = \frac{E_{max} B_{max}}{2\mu_0} \quad E_{max} = c \cdot B_{max}$$

$$159.15 = \frac{(3 \times 10^8)(B_{max})^2}{2(4\pi \times 10^{-7})} \quad \boxed{B_{max} = 1.15 \times 10^{-6} \text{ T}}$$

$$E_{max} = (3 \times 10^8)(1.15 \times 10^{-6}) = \boxed{346.4 \text{ V/m}}$$

$$d) u = \epsilon_0 E^2$$

$$u_{avg} = \epsilon_0 (E_{rms})^2$$

$$E_{rms} = \frac{E_{max}}{\sqrt{2}} \quad u_{av} = \frac{\epsilon_0 E_{max}^2}{2} = \frac{(8.854 \times 10^{-12})(346.4)^2}{2} = \boxed{5.31 \times 10^{-7} \text{ J/m}^3}$$



6.1 2 / 2

✓ - 0 pts Correct

- 1 pts Incorrect formula

- 0.5 pts Numerical error

Problem 6 (10 pts)

Please make sure to write down *intermediate steps* of your calculations, for partial credits.

A new professor in the university recently built his own laser. This laser can produce light of wavelength 500 nm and a power of 0.500 mW spread over a cylindrical beam with 1.00 mm in radius.

- (a) (2 pts) What is the intensity of this laser beam?
- (b) (2 pts) What average pressure does this laser exert on a totally reflecting surface?
- (c) (3 pts) What are the maximum values of the electric and magnetic fields?
- (d) (3 pts) What is the average energy density in the laser beam?

$$a) P_{av} = IA \quad I = \frac{P}{A} = \frac{0.5 \times 10^{-3}}{\pi (1 \times 10^{-3})^2} = \boxed{159.15 \text{ W/m}^2}$$

$$b) P_{rad} = \frac{2I}{c} = \frac{2 (159.15)}{3 \times 10^8} = \boxed{1.06 \times 10^{-6} \text{ Pa}}$$

$$c) I = \frac{E_{max} B_{max}}{2\mu_0} \quad E_{max} = c \cdot B_{max}$$

$$159.15 = \frac{(3 \times 10^8)(B_{max})^2}{2(4\pi \times 10^{-7})} \quad \boxed{B_{max} = 1.15 \times 10^{-6} \text{ T}}$$

$$E_{max} = (3 \times 10^8)(1.15 \times 10^{-6}) = \boxed{346.4 \text{ V/m}}$$

$$d) u = \epsilon_0 E^2$$

$$u_{avg} = \epsilon_0 (E_{rms})^2$$

$$E_{rms} = \frac{E_{max}}{\sqrt{2}} \quad u_{av} = \frac{\epsilon_0 E_{max}^2}{2} = \frac{(8.854 \times 10^{-12})(346.4)^2}{2} = \boxed{5.31 \times 10^{-7} \text{ J/m}^3}$$

6.2 2 / 2

✓ - 0 pts Correct

- 1 pts Incorrect formula

- 0.5 pts Numerical error

- 0.25 pts Successive numerical error

- 2 pts Blank

Problem 6 (10 pts)

Please make sure to write down *intermediate steps* of your calculations, for partial credits.

A new professor in the university recently built his own laser. This laser can produce light of wavelength 500 nm and a power of 0.500 mW spread over a cylindrical beam with 1.00 mm in radius.

- (a) (2 pts) What is the intensity of this laser beam?
- (b) (2 pts) What average pressure does this laser exert on a totally reflecting surface?
- (c) (3 pts) What are the maximum values of the electric and magnetic fields?
- (d) (3 pts) What is the average energy density in the laser beam?

$$a) P_{av} = IA \quad I = \frac{P}{A} = \frac{0.5 \times 10^{-3}}{\pi (1 \times 10^{-3})^2} = \boxed{159.15 \text{ W/m}^2}$$

$$b) P_{rad} = \frac{2I}{c} = \frac{2 (159.15)}{3 \times 10^8} = \boxed{1.06 \times 10^{-6} \text{ Pa}}$$

$$c) I = \frac{E_{max} B_{max}}{2\mu_0} \quad E_{max} = c \cdot B_{max}$$

$$159.15 = \frac{(3 \times 10^8)(B_{max})^2}{2(4\pi \times 10^{-7})} \quad \boxed{B_{max} = 1.15 \times 10^{-6} \text{ T}}$$

$$E_{max} = (3 \times 10^8)(1.15 \times 10^{-6}) = \boxed{346.4 \text{ V/m}}$$

$$d) u = \epsilon_0 E^2$$

$$u_{avg} = \epsilon_0 (E_{rms})^2$$

$$E_{rms} = \frac{E_{max}}{\sqrt{2}} \quad u_{av} = \frac{\epsilon_0 E_{max}^2}{2} = \frac{(8.854 \times 10^{-12})(346.4)^2}{2} = \boxed{5.31 \times 10^{-7} \text{ J/m}^3}$$

6.3 3 / 3

✓ - 0 pts Correct

- 1 pts Incorrect formula for E

- 1 pts Incorrect or no formula for B

- 0.5 pts Numerical error

- 0.25 pts Numerical error for B

- 3 pts Blank

Problem 6 (10 pts)

Please make sure to write down *intermediate steps* of your calculations, for partial credits.

A new professor in the university recently built his own laser. This laser can produce light of wavelength 500 nm and a power of 0.500 mW spread over a cylindrical beam with 1.00 mm in radius.

- (a) (2 pts) What is the intensity of this laser beam?
- (b) (2 pts) What average pressure does this laser exert on a totally reflecting surface?
- (c) (3 pts) What are the maximum values of the electric and magnetic fields?
- (d) (3 pts) What is the average energy density in the laser beam?

$$a) P_{av} = IA \quad I = \frac{P}{A} = \frac{0.5 \times 10^{-3}}{\pi (1 \times 10^{-3})^2} = \boxed{159.15 \text{ W/m}^2}$$

$$b) P_{rad} = \frac{2I}{c} = \frac{2 (159.15)}{3 \times 10^8} = \boxed{1.06 \times 10^{-6} \text{ Pa}}$$

$$c) I = \frac{E_{max} B_{max}}{2\mu_0} \quad E_{max} = c \cdot B_{max}$$

$$159.15 = \frac{(3 \times 10^8)(B_{max})^2}{2(4\pi \times 10^{-7})} \quad \boxed{B_{max} = 1.15 \times 10^{-6} \text{ T}}$$

$$E_{max} = (3 \times 10^8)(1.15 \times 10^{-6}) = \boxed{346.4 \text{ V/m}}$$

$$d) u = \epsilon_0 E^2$$

$$u_{avg} = \epsilon_0 (E_{rms})^2$$

$$E_{rms} = \frac{E_{max}}{\sqrt{2}} \quad u_{av} = \frac{\epsilon_0 E_{max}^2}{2} = \frac{(8.854 \times 10^{-12})(346.4)^2}{2} = \boxed{5.31 \times 10^{-7} \text{ J/m}^3}$$

6.4 3 / 3

✓ - 0 pts Correct

- 1.5 pts Incorrect formula

- 0.25 pts Successive numerical error

- 0.5 pts Numerical error

- 3 pts Blank

Problem 7 (10 pts)

Please make sure to write down *intermediate steps* of your calculations, for partial credits.

For a  $R$ - $L$  circuit as shown in the figure, the voltage  $\varepsilon = 12.0$  V, the resistance  $R = 100$   $\Omega$ , and the inductance  $L = 0.01$  H. Suppose both switches are open to begin with, and then at some initial time  $t = 0$ , we close switch  $S_1$  (leave  $S_2$  still open). The current  $i$  is shown in the figure.

- (a) (5 pts) Please obtain an expression of the current  $i$  as a function of time  $t$ . If one denotes the value of the current as  $I_0$  when  $t \rightarrow \infty$ , please determine  $I_0$ .
- (b) (5 pts) Please calculate the instantaneous power  $P_L$  in the inductor as a function of  $t$ . At what value of  $t$ ,  $P_L$  is a maximum?

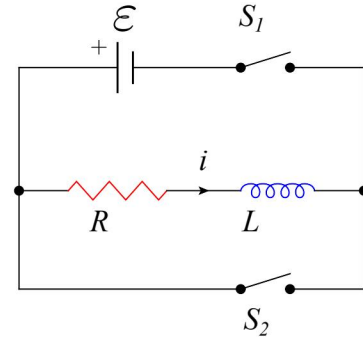

$$a) \quad i = \frac{\varepsilon}{R} \left[ 1 - e^{-\frac{R}{L}t} \right] \quad \text{for } R\text{-}L \text{ circuit}$$

$$i = \frac{12 \text{ V}}{100 \, \Omega} \left[ 1 - e^{-\frac{100}{0.01}t} \right]$$

$$= 0.12 \text{ A} \left[ 1 - e^{-(10^4 \text{ s}^{-1})t} \right]$$

$$\text{as } t \rightarrow \infty, \quad e^{-\frac{R}{L}t} \rightarrow 0$$

$$i \rightarrow I_0 = \frac{\varepsilon}{R} = \frac{12 \text{ V}}{100 \, \Omega} = \boxed{0.12 \text{ A}}$$



7.1 5 / 5

✓ - 0 pts Correct

- 2 pts Incorrect Kirchhoff's laws
- 1.5 pts Solving differential equation
- 1 pts Error in expression
- 0.5 pts Incorrect  $I_0$
- 1 pts Incorrect  $I_0$
- 3 pts Incorrect expression with no explanation
- 5 pts Blank
- 2 pts Correct general form but with no specification
- 3 pts Correct but incomplete

Problem 7 (10 pts)

Please make sure to write down *intermediate steps* of your calculations, for partial credits.

For a  $R$ - $L$  circuit as shown in the figure, the voltage  $\varepsilon = 12.0$  V, the resistance  $R = 100$   $\Omega$ , and the inductance  $L = 0.01$  H. Suppose both switches are open to begin with, and then at some initial time  $t = 0$ , we close switch  $S_1$  (leave  $S_2$  still open). The current  $i$  is shown in the figure.

(a) (5 pts) Please obtain an expression of the current  $i$  as a function of time  $t$ . If one denotes the value of the current as  $I_0$  when  $t \rightarrow \infty$ , please determine  $I_0$ .

(b) (5 pts) Please calculate the instantaneous power  $P_L$  in the inductor as a function of  $t$ . At what value of  $t$ ,  $P_L$  is a maximum?

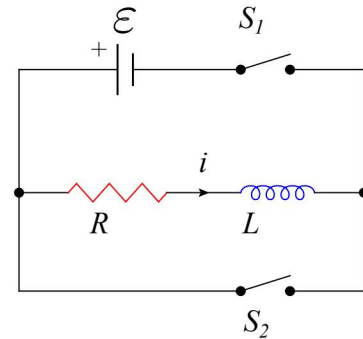

$$b) P_L = v_L \cdot i$$

$$v_L = L \frac{di}{dt} = L \frac{\lambda}{\lambda t} \left[ \frac{\varepsilon}{R} (1 - e^{-\frac{R}{L}t}) \right]$$

$$= L \cdot \left(-\frac{\varepsilon}{R}\right) e^{-\frac{R}{L}t} \left(-\frac{R}{L}\right)$$

$$= \varepsilon e^{-\frac{R}{L}t}$$

$$P_L = v_L \cdot i = \varepsilon e^{-\frac{R}{L}t} \cdot \frac{\varepsilon}{R} (1 - e^{-\frac{R}{L}t})$$

$$= \frac{\varepsilon^2}{100} e^{-\frac{R}{L}t} (1 - e^{-\frac{R}{L}t})$$

$$= (1.44 \text{ W}) e^{-(10^4 \text{ s}^{-1})t} (1 - e^{-(10^4 \text{ s}^{-1})t})$$

$$\frac{dP_L}{dt} = 0 \quad \frac{d}{dt} \left[ \frac{\varepsilon^2}{R} e^{-\frac{R}{L}t} (1 - e^{-\frac{R}{L}t}) \right] = 0$$

$$\frac{\varepsilon^2}{R} \left[ -\frac{R}{L} e^{-\frac{R}{L}t} + \frac{2R}{L} e^{-\frac{2R}{L}t} \right] = 0$$

$$\frac{2R}{L} e^{-\frac{2R}{L}t} = \frac{R}{L} e^{-\frac{R}{L}t} \quad 2e^{-\frac{2R}{L}t} = e^{-\frac{R}{L}t}$$

$$2e^{-\frac{R}{L}t} = 1 \quad \frac{R}{L}t = \ln 2$$

$$t = \ln 2 \cdot \frac{L}{R} = \ln 2 \cdot \frac{0.01}{100} = \boxed{6.9 \times 10^{-5} \text{ s}}$$

7.2 5 / 5

✓ - 0 pts Correct

- 2 pts Error in the expression of  $P_L$
- 1 pts Error in the expression of  $P_L$
- 2 pts Error in the way to find  $t$  for maximal  $P_L$
- 1 pts Error in the way to find  $t$  for maximal  $P_L$
- 1.5 pts No answer to  $t$  for maximal  $P_L$
- 1 pts Incomplete in finding  $t$  for maximal  $P_L$
- 1 pts Numerical error
- 0.5 pts Numerical error
- 3 pts Incomplete
- 5 pts Blank